

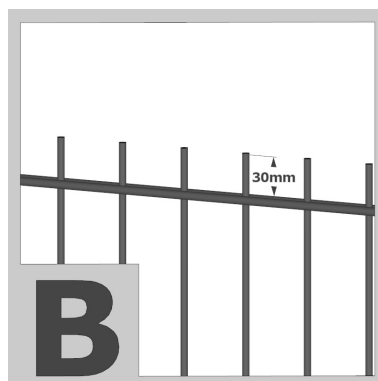

2580 mm  
 Rozstaw osiowy słupków



**C**  
 JEDNOSTRONNIE  
 KRAWĘDŹ *safe*  
 brak wystających drutów



**B**  
 KRAWĘDŹ STANDARD  
 drut ca. 30mm

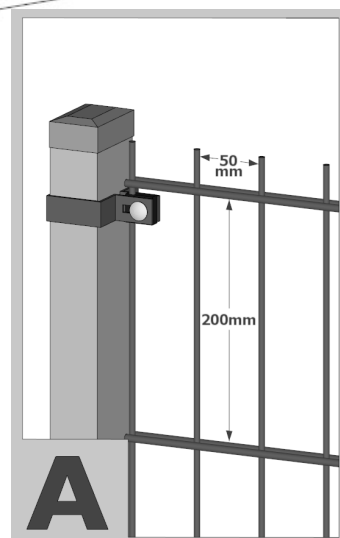

**A**  
 ROZSTAW DRUTÓW  
 50x200[mm]

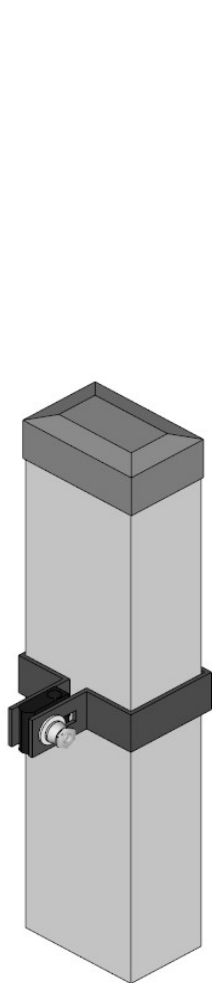

OBEJMA STARTOWA

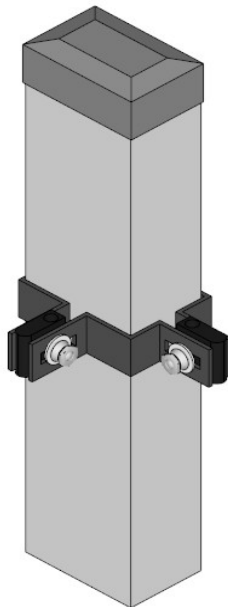

OBEJMA NAROŻNA

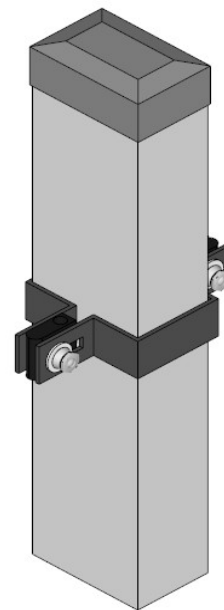

OBEJMA POŚREDNIA

Element	
1	Słup 40x60x2[mm] / SłupE 40x60x1,25[mm] eco
2	Zaślepka zewnętrzna PCV
3	Strzemiona obejmy 40x60[mm]
4	Śruba zamkowa M8x25 INOX
5	Nakrętka zrywalna + podkładka INOX
6	Dystans PCV Ø5mm / Ø6mm

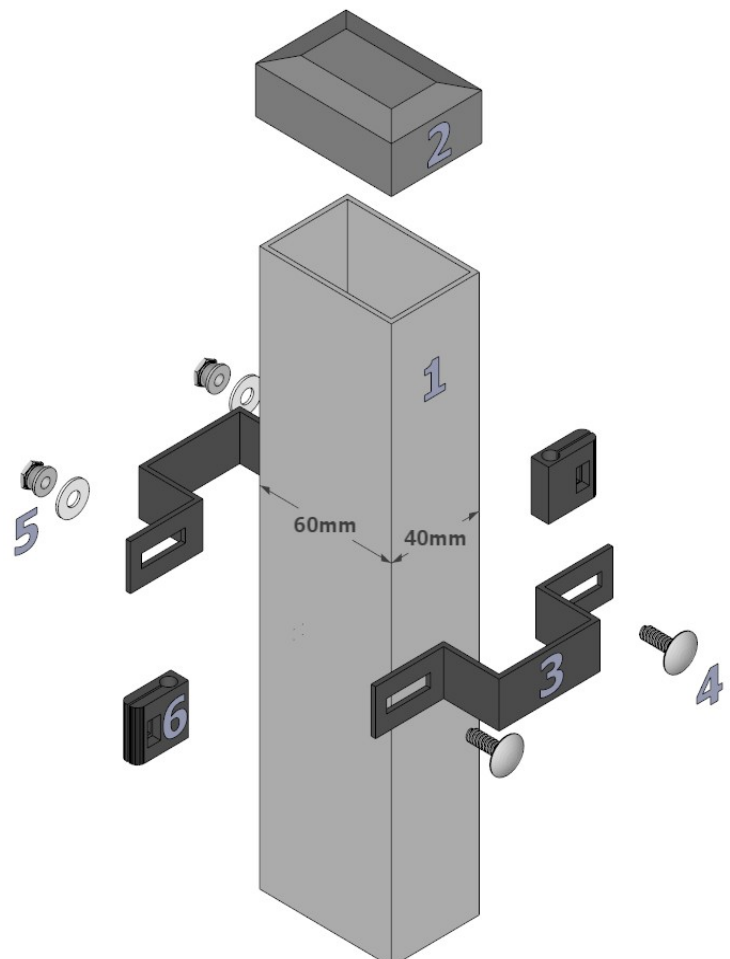

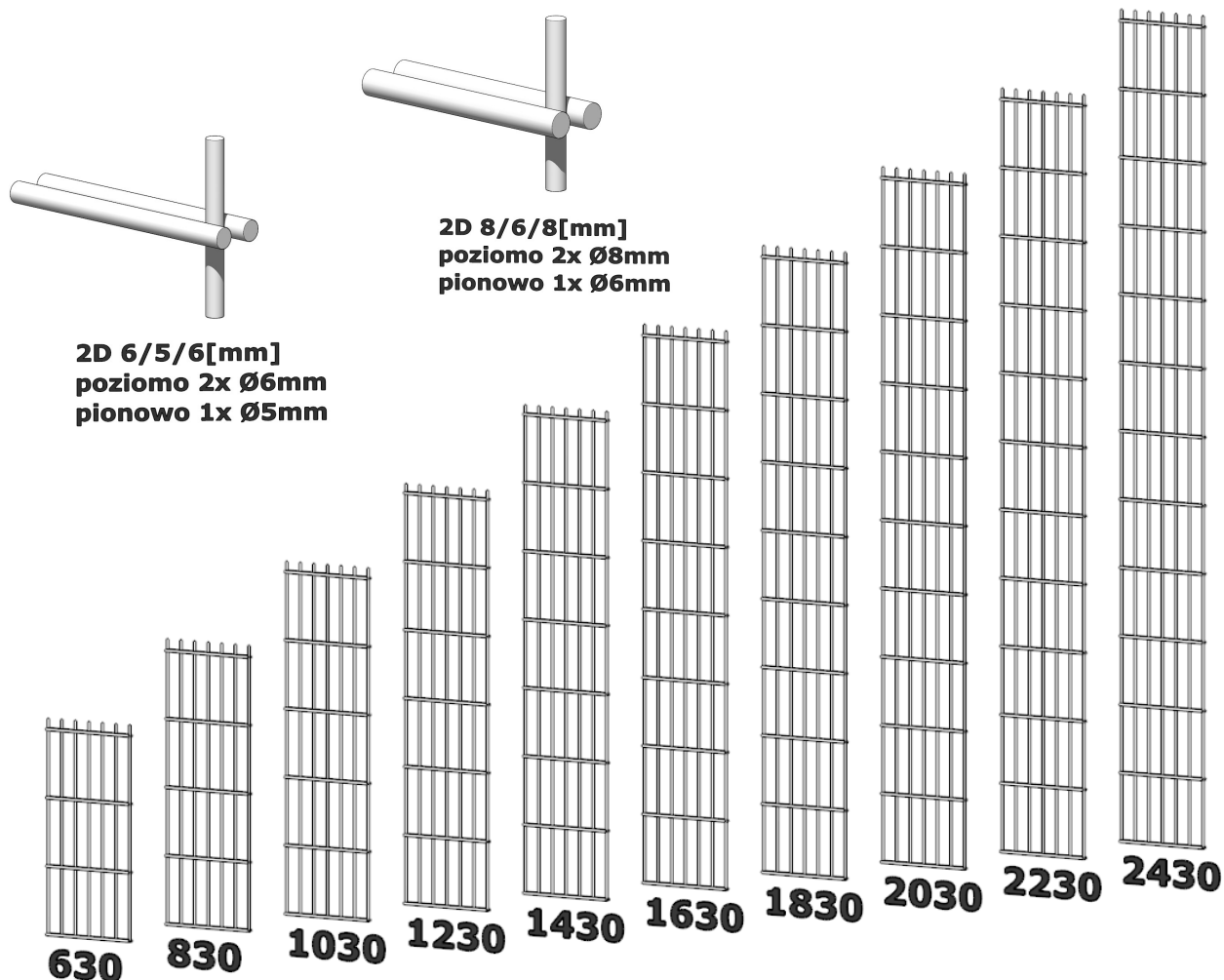

Typ	Wysokość panelu mm	Waga 2D 6/5/6 kg	Waga 2D 8/6/8 kg	Wysokość słupa mm
2D/H630	630	8,00	14,00	1200
2D/H830	830	11,00	18,00	1400
2D/H1030	1030	13,00	22,00	1600
2D/H1230	1230	16,00	26,00	1800
2D/H1430	1430	18,00	29,00	2000
2D/H1630	1630	21,00	34,00	2200
2D/H1830	1830	23,00	37,00	2400
2D/H2030	2030	25,00	42,00	2600
2D/H2230	2230	28,00	45,00	3000
2D/H2430	2430	30,00	50,00	3200